



THANK YOU FOR BUYING A WHIRLPOOL PRODUCT
In order to receive a more complete assistance, please register your product on www.whirlpool.eu/register



Before using the appliance carefully read the Safety Instruction.

FIRST TIME USE

HEAT THE OVEN

A new oven may release odours that have been left behind during manufacturing: this is completely normal. Therefore, before starting to cook food, we recommend heating the empty oven in order to remove any possible odors. Remove any protective cardboard or transparent film from

the oven and remove any accessories from inside it. Heat the oven to 250°C for about one hour: The oven must be empty during this time. Follow the instructions for setting the function correctly.

Please note: We recommend to ventilate the room after using the appliance for the first time.

CONTROL PANEL

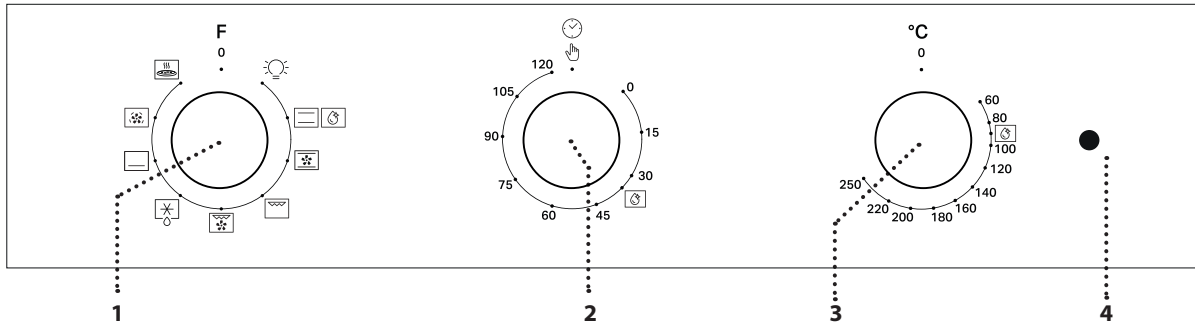

1. SELECTION KNOB

For switching the oven on or by selecting a function. Turn to the position **0** to switch the oven off.

2. TIMER KNOB

Useful as a timer.

3. THERMOSTAT KNOB

Turn to select a desired temperature, activating the selected function.

4. LED THERMOSTAT / PREHEATING

Switches on during the heating process. Switches off once the desired temperature is reached.

Please note: Placing the food in the oven before preheating has finished may have an adverse effect on the final cooking result.

Please note: Type of knobs may vary from model type. If the knobs are push activated, push down on the center of the knob to release it from seating.

ACCESSORIES

The number and type of accessories may vary depending on which model is purchased. Other accessories that are not supplied can be purchased separately from the After-sales Service.



WIRE SHELF Use to cook food or as a support for pans, cake tins and other ovenproof items of cookware.



DRIP TRAY* Use as an oven tray for cooking meat, fish, vegetables, focaccia, etc. or position underneath the wire shelf to collect cooking juices.



BAKING TRAY* Use for cooking all bread and pastry products, but also for roasts, fish en papillote, etc.

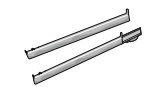

SLIDING RUNNERS* To facilitate inserting or removing accessories.

Insert the wire shelf onto the level you require by holding it tilted slightly upwards and resting the raised rear side (pointing upwards) down first. Then slide it horizontally along the shelf guide as far as possible. The other accessories, such as the baking tray, are inserted horizontally by sliding them along the shelf guides.

REMOVING AND REFITTING THE SHELF GUIDES

The shelf guides can be removed to facilitate the oven cleaning: pull them to remove from their seats.

* Available only on certain models.

FUNCTIONS & DAILY USE

1. SELECT A FUNCTION

To select a function, turn the *selection knob* to the symbol for the function you require.

0 OFF
For switching off the oven.

LIGHT
For switching on the light in the compartment.

CONVENTIONAL
For cooking any kind of dish on one shelf only.

SMART CLEAN (Available only on certain models)
The action of the steam released during this special low-temperature cleaning cycle allows dirt and food residues to be removed with ease. To activate the "Smart Clean" cleaning function pour 100-120ml of drinking water into the bottom of the oven then turn all the 3 knobs (selection knob, timer knob, thermostat knob) to icon.



CONVECTION BAKE
For baking cakes with juicy fillings on a single shelf. This function can also be used for cooking on two shelves.



GRILL
For grilling steaks, kebabs and sausages, cooking vegetables au gratin or toasting bread. When grilling meat, we recommend using a tray to collect the cooking juices: Position the tray on any of the levels below the wire shelf and add 200 ml of drinking water.



TURBOGRILL
For roasting large joints of meat. We recommend using a tray to collect the cooking juices: Position the tray on any of the levels below the wire shelf and add 200 ml of drinking water.



DEFROSTING
For defrosting food more quickly.



BOTTOM HEATING
For browning the bottom of the dishes. The function can also be used for slow cooking, to finish cooking very liquid dishes (sweet or savour) or to thicken sauces and gravies.

 **FORCED AIR**
For cooking different foods that require the same cooking temperature on several shelves (maximum three) at the same time. This function can be used to cook different foods without odours being transferred from one food to another.

 **PIZZA**
For baking different types and sizes of pizza and bread. It is a good idea to swap the position of the baking trays halfway through cooking.

DAILY USE

1. SELECT A FUNCTION

To select a function, turn the *selection knob* to the symbol of the function you require.

2. ACTIVATE A FUNCTION

MANUAL

Turn the selector knob to the required function. The oven light switches on.

Turn the thermostat knob clockwise to the required temperature.

At the end of cooking, to switch off the oven, turn the *selection knob* and the *thermostat knob* to **0**.

SMART CLEAN

To activate the "Smart Clean" cleaning function, pour 100 - 120 ml of drinking water into the bottom of the oven, then turn all the 3 knobs (selection knob, timer knob, thermostat knob) to  icon.

The function will activate automatically and its duration is 35'.

3. PREHEATING

Once the function has been activated, the thermostat LED light will switch on signalling that the preheating process has begun.

At the end of this process, thermostat LED light switches off indicating that the oven has reached the set temperature. At this point, the oven is ready to place the food inside and proceed with cooking.































Please note: Placing the food in the oven before preheating has finished may have an adverse effect on the final cooking result.

4. SETTING THE TIMER













The timer knob can be used to set a cooking time of between 1 and 120 minutes. To set cooking time, after selecting the required cooking function, turn the knob right round in a clockwise direction and then turn it back in the opposite direction to the desired cooking duration. At the end of the set cooking time the oven switches off and the selector remains positioned at **0**. To use the oven in manual mode, i.e. without setting a cooking time, be sure that the timer knob is turned to the  symbol.

IMPORTANT: when the timer knob is positioned at **0** the oven will not switch on. To switch the oven on, set the knob to  symbol or set a cooking time.

COOKING TABLE

RECIPE	FUNCTION	PREHEAT	TEMPERATURE (°C)	DURATION (MIN)	LEVEL AND ACCESSORIES
Leavened cakes		Yes	150 - 170	30 - 90	2 
		Yes	160 - 180	30 - 90	4 1  
Biscuits / tartlets		Yes	160 - 180	15 - 35	2 / 3 
		Yes	150 - 170	20 - 45	4 2  
Pizza / bread		Yes	90	140 - 200	4 2  
		Yes	90	140 - 200	5 3 1   
Lasagne / baked pasta / cannelloni / flans		Yes	180 - 200	35 - 50	5 3 1   
Lamb / veal / beef / 1 kg		Yes	190 - 200	20 - 30	2 
Chicken / rabbit / duck 1 kg		Yes	200 - 230	50 - 100	5 3 1   
Toasted bread		5'	250	2 - 6	5 
Roast potatoes		-	200 - 220	35 - 55 *	3 

* Turn food two-thirds of the way through cooking (if necessary).

ACCESSORIES	 Rack	 Baking dish or baking tray on the wire shelf	 Drip tray / Dessert tray / Baking tray on wire shelf	 Drip tray	 Drip tray with 200 ml of water	 BAKING TRAY
FUNCTIONS	 Conventional	 Grill	 Turbo Grill	 Forced Air	 Convection Bake	 Pizza

CLEANING AND MAINTENANCE

Make sure that the oven has cooled down before carrying out any maintenance or cleaning. Do not use steam cleaners. Do not use wire wool, abrasive scourers or abrasive/corrosive cleaning agents, as these could damage the surfaces of the appliance. Wear protective gloves. The oven must be disconnected from the mains before carrying out any kind of maintenance work.

EXTERIOR SURFACES

Clean surfaces with a damp microfibre cloth. If they are very dirty, add a few drops of pH-neutral detergent. Finish off with a dry cloth. Do not use corrosive or abrasive detergents. If any of these products inadvertently comes into contact with the surfaces of the appliance, clean immediately with a damp microfibre cloth.

INTERIOR SURFACES

After every use, leave the oven to cool and then clean it, preferably while it is still warm, to remove any deposits or stains caused by food residues. To dry any condensation that has formed as a result of cooking foods with a high water content, leave the oven to cool completely and then wipe it with a cloth or sponge. Activate the "Smart Clean" function for optimum cleaning of internal surfaces (Available only on certain models). Clean the glass in the door with a suitable liquid detergent.

ACCESSORIES

Soak the accessories in a washing-up liquid solution after use, handling them with oven gloves if they are still hot. Food residues can be removed using a washing-up brush or a sponge.

LOWER THE TOP HEATING ELEMENT (Only in some models)

The top heating element of the grill can be lowered to clean the upper panel of the oven: Extract the heating element from its seating, then lower it. To return the heating element to its position, lift it up, pull it slightly towards you and make sure that the tab support is in its proper seating.

REMOVING AND REFITTING THE DOOR

To remove the door, open it fully and lower the catches until they are in the unlock position (1). Close the door as much as you can (2). Take a firm hold of the door with both hands - do not hold it by the handle. Simply remove the door (3) by continuing to close it while pulling it upwards (a) at the same time until it is released from its seating (b).

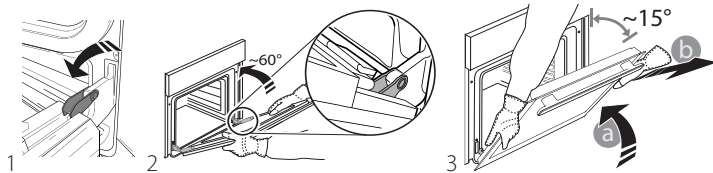

Put the door on one side, resting it on a soft surface. Refit the door by moving it towards the oven, aligning the hooks of the hinges with their seating and securing the upper part onto its seating. Lower the door and then open it fully. Lower the catches into their original position: make sure that you lower them down completely. Try closing the door and check to make sure that it lines up with the control panel. If it does not, repeat the steps above.

CLEANING OF THE DOOR GLASSES

After removing the door and resting it on a soft surface with the handle downwards, simultaneously press the two retaining clips (1) and remove the upper edge of the door by pulling it towards you (2).

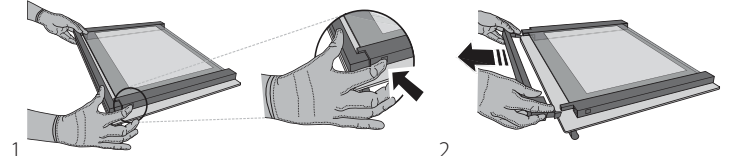

Lift and firmly hold the inner glass with both hands, remove it and place it on a soft surface before cleaning it (3).

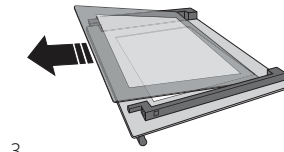

To correctly reposition the inner glass, make sure that the "R" is visible in the left-hand corner and the clear surface (not printed) is facing up. First insert the long side of the glass indicated by "R" into the support seats, then lower it into position (4). Refit the upper edge (5): a click will indicate correct positioning. Make sure the seal is secure before refitting the door.

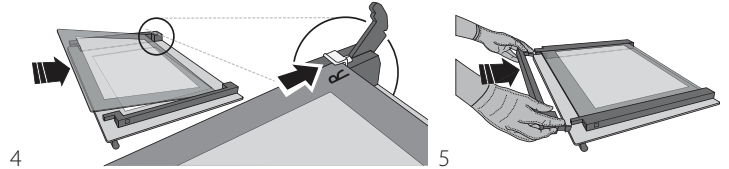

REPLACING THE LAMP

Disconnect the oven from the power supply, unscrew the cover from the light, replace the bulb and screw the cover back on the light. Reconnect the oven to the power supply. Do not use the oven until the light cover has been refitted.

Please note: Only use 25W/230 ~ V, G9 type, T300°C halogen bulbs. The bulb used in the product is specifically designed for domestic appliances and is not suitable for general room lighting within the home. Light bulbs are available from our After-sales Service.

TROUBLESHOOTING

What to do if...	Possible reasons	Solutions
The oven is not working.	Power cut. Disconnection from the mains.	Check for the presence of mains electrical power and whether the oven is connected to the electricity supply. Turn off the oven and restart it to see if the fault persists.

▼ Download the complete Daily Reference Guide from docs.whirlpool.eu for more informations about your product



Policies, standard documentation and additional product information can be found by:

- Visiting our website docs.whirlpool.eu
- Using QR Code
- Alternatively, **contact our After-sales Service** (See phone number in the warranty booklet). When contacting our After-sales Service, please state the codes provided on your product's identification plate.

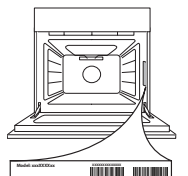

Whirlpool



400011632844